

US2-M | metric thread**Connectors**

Metal connector, safety-type, straight, metric inner thread, incl. ferrule [brass] and sealing [TPE]

Temperature: -40°C ... +125°C

Material: nickel-plated brass

Protection class [acc. to EN 60529]: IP55

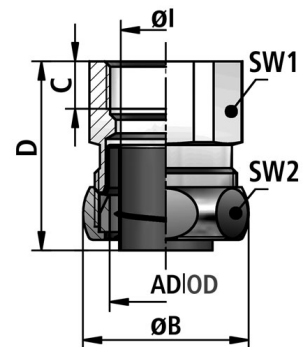

FLEXA No.	OD [mm]	Thread type	Conduit DI	Conduit OD	Ø1 [mm]	ØB [mm]	C [mm]	D [mm]	WS1 [mm]	WS2 [mm]	Weight [kg/100]	PU [pcs.]
15012328010	10,0	M 10 x 1,0	7,0	10,0	6,0	19,0	8,0	26,0	15	17	1,500	25
15012328012	14,0	M12 x 1,5	10,0	14,0	8,5	23,0	8,0	27,0	21	21	2,300	25
15012328016	17,0	M16 x 1,5	13,0	17,0	11,5	27,0	8,0	27,0	24	25	3,000	25
15012328020	21,0	M20 x 1,5	17,0	21,0	15,5	31,0	10,0	30,0	30	29	4,000	25
15012328025	27,0	M25 x 1,5	22,0	27,0	20,5	39,0	11,0	37,0	36	36	7,600	10
15012328032	36,0	M32 x 1,5	29,0	36,0	27,5	48,0	11,0	39,0	46	45	10,100	10
15012328040	45,0	M40 x 1,5	38,0	45,0	35,0	57,0	12,0	42,0	55	54	13,500	5
15012328050	56,0	M50 x 1,5	49,0	56,0	45,0	70,0	12,0	46,0	65	66	20,000	5

Recommendations for any areas of applications, products, or product combinations are issued to the best of FLEXA's knowledge and experience. The user is requested to check applicability of FLEXA products to specific applications and purposes prior to the use of the particular products. All documentation, illustrations, and charts published are subject to copyright and must not be copied, changed, used, or modified. Technical drawings, certificates, authorizations, and results by the FLEXA lab will be provided upon request. FLEXA will not be held liable for typographical or other errors and incorrect drawings. Technical modifications are subject to change without prior notice.