

## USW-PG | PG thread

## Connectors

Metal connector, safety-type, 90° elbow, PG outer thread, incl. ferrule [brass], sealing and O-ring [NBR]

**Temperature:** -40°C ... +125°C

**Material:** nickel-plated brass

**Protection class [acc. to EN 60529]:** IP55

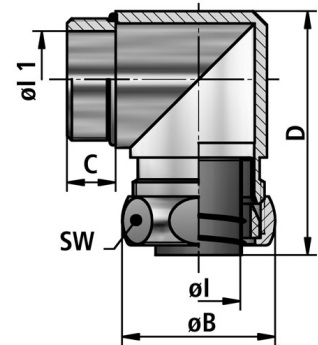

FLEXA No.	OD [mm]	Thread type	Conduit DI	Conduit OD	Ø I [mm]	Ø B [mm]	C [mm]	D [mm]	WS [mm]	Weight [kg/100]	PU [pcs.]
15010228007	10,0	PG7	7,0	10,0	6,0	19,0	9,0	36,0	17	2,800	25
15010227009	14,0	PG9	11,0	14,0	10,0	23,0	9,0	41,0	21	3,600	25
15010228011	17,0	PG11	13,0	17,0	11,5	27,0	8,0	45,0	25	5,900	25
15010228013	19,0	PG13,5	15,0	19,0	13,5	29,0	10,0	49,5	27	7,700	25
15010228016	21,0	PG16	17,0	21,0	15,5	31,0	10,0	52,0	29	10,000	25
15010240021	27,0	PG21	23,0	27,0	21,5	39,0	10,5	58,0	36	13,400	10
15010228029	36,0	PG29	29,0	36,0	27,5	48,0	11,0	72,0	45	23,300	10

Recommendations for any areas of applications, products, or product combinations are issued to the best of FLEXA's knowledge and experience. The user is requested to check applicability of FLEXA products to specific applications and purposes prior to the use of the particular products. All documentation, illustrations, and charts published are subject to copyright and must not be copied, changed, used, or modified. Technical drawings, certificates, authorizations, and results by the FLEXA lab will be provided upon request. FLEXA will not be held liable for typographical or other errors and incorrect drawings. Technical modifications are subject to change without prior notice.